

G Series – GMG Refrigerated Service Cases



Models

GMG3
GMG4
GMG6
GMG8
GMG12
GMGX2
GMGX4
GMGX9
GMGN2
GMGN4
GMGN9

Applications

- Convection refrigeration
- Medium temperature integrated average of 38°F
- Single deck display
- For refrigerated meat & seafood
- Corrosion resistant stainless steel tub & fan shroud
- Designed to be used with GMSD, GMSH, GMSSD, GMSB & GMSSB models

Service deli merchandisers - gravity coil refrigeration

Standard Features

- Stainless steel interior
- Painted exterior
- Black trim
- No end panels (specify ends per lineup)
- Curved single pane lift-up front glass
- Angled clear glass rear sliding doors
- T-8 top light
- Electrical leads
- Remote refrigeration with TXV
- ETL certified to CAN/CSA 22.2, conforms to UL 471 & NSF 7
- Meets DOE 2012 Energy Standards

Options

- Stainless steel or laminated exterior
- Silver trim
- Full w/mirror, cutaway or case to case glass end panels
- Straight single pane lift-up front glass
- Angled reflective glass rear sliding doors
- LED lights
- Ice pans for seafood application
- Coated evaporator coil
- Top mount scale stand with receptacle
- Rear wrapping board
- Front glass & rear door locks
- 1" bumper on front

ONE PART PASSION, TWO PARTS SCIENCE



Specifications - GMG Refrigerated Cases

Model	L*xDxH
GMG3	36-3/4"x 43-3/8"x 51-1/4"
GMG4	48-3/4"x 43-3/8"x 51-1/4"
GMG6	73-1/8"x 43-3/8"x 51-1/4"
GMG8	97-1/2"x 43-3/8"x 51-1/4"
GMG12	146-1/4"x 43-3/8"x 51-1/4"
GMGX2	47-1/4"x 43-3/8"x 51-1/4"
GMGX4	39-1/8"x 43-3/8"x 51-1/4"
GMGX9	72-1/4"x 43-3/8"x 51-1/4"
GMGN2	38-5/8"x 43-3/8"x 51-1/4"
GMGN4	53-1/4"x 43-3/8"x 51-1/4"
GMGN9	98-3/8"x 43-3/8"x 51-1/4"

*without 1" end panels GMGX models = convex/outside curve
 GMGN models = concave/inside curve

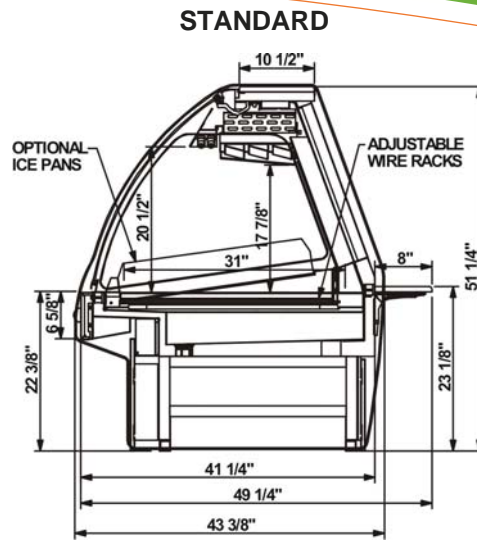

IMPORTANT NOTES

Units must be shimmed during installation to ensure the unit is level and plumb.

INTENDED ENVIRONMENT

Designed to operate in ambient conditions of 75°F with 55% relative humidity.

Integrated average product temperature of 38°F.

INTENDED USE

Unpackaged refrigerated products.

For more information on any of our products or services please visit us on the web at:

www.structuralconcepts.com

GMGX2 PLAN VIEW

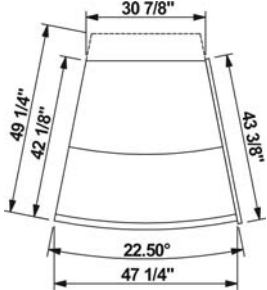

GMGX4 PLAN VIEW

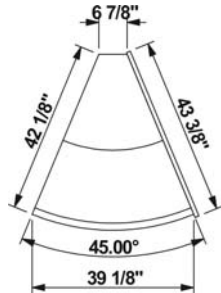

GMGX9 PLAN VIEW

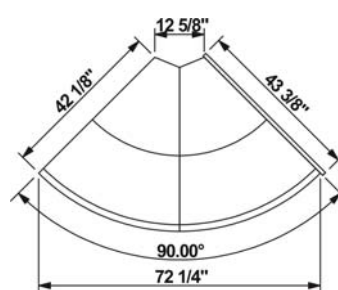

GMGN2 PLAN VIEW

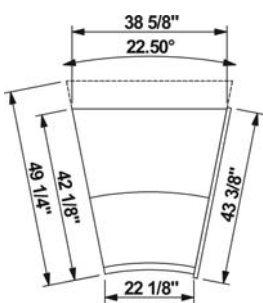

GMGN4 PLAN VIEW

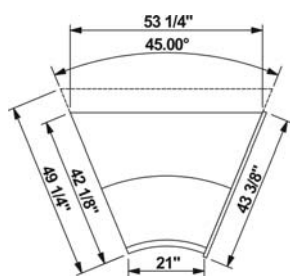

GMGN9 PLAN VIEW

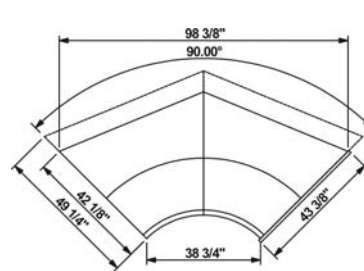

INFORMATION IS SUBJECT TO CHANGE WITHOUT NOTICE.

